

Description

The 15KP series is designed specifically to protect sensitive electronic equipment from voltage transients induced by lightning and other transient voltage events.

Features

- Halogen free and RoHS compliant
- Glass passivated junction
- Low incremental surge resistance
- Excellent clamping capability
- 15000W peak pulse power capability at 10/1000 μ s waveform, repetition rate (duty cycle): 0.05%
- Fast response time
- Typical I_R less than 2 μ A above 30V devices
- High Temperature soldering guaranteed: 265 $^{\circ}$ C/10 seconds/.375", (9.5mm) lead length, 5lbs (2.3kg) tension
- Plastic package has underwriters laboratory flammability 94V-0
- Meet MSL level1, per J-STD-020
- IEC-61000-4-2 ESD 30kV(Air), 30kV (Contact)
- Unit Weight: 2.3g



Applications

TVS components are ideal for the protection of I/O Interfaces, VCC bus and other vulnerable circuits used in telecom, computer, Industrial and consumer electronic applications.

Maximum Ratings and Characteristics ($T_A=25^{\circ}$ C)

Rating	Symbol	Value
Peak pulse power dissipation at 10/1000 μ s waveform (Note1, Fig.1)	P_{PPM}	15000W
Peak pulse current of at 10/1000 μ s waveform (Note 1, Fig.3)	I_{PPM}	See Table(A)
Steady state power dissipation at $T_L=75^{\circ}$ C (Fig.5)	$P_{M(AV)}$	8.0W
Peak forward surge current, 8.3ms single half sine-wave superimposed on rated load, (JEDEC Method) (Note2, Fig.6)	I_{FSM}	400A
Operating junction and Storage Temperature Ranges	T_J, T_{STG}	-55 $^{\circ}$ C to +150 $^{\circ}$ C
Typical thermal resistance junction to lead	$R_{\theta JL}$	8 $^{\circ}$ C/W
Typical thermal resistance junction to ambient	$R_{\theta JA}$	40 $^{\circ}$ C/W

Notes:1. Non-repetitive current pulse, per Fig.3 and derating above $T_A=25^{\circ}$ C per Fig.2.

2. 8.3ms single half sine-wave or equivalent square wave, duty cycle=4 pulses per minutes maximum.

Electrical Characteristics (T_A=25°C)

Part Number		Reverse Stand-Off Voltage	Breakdown Voltage @I _T		Test Current	Maximum Clamping Voltage @I _{PP}	Peak Pulse Current	Reverse Leakage @V _R
Uni.	Bi.	V _R (V)	V _{B Min.} (V)	V _{B Max.} (V)	I _T (mA)	V _C (V)	I _{PP} (A)	I _R (μA)
15KP17A	15KP17CA	17.0	18.99	21.22	50	29.3	515.4	2500
15KP18A	15KP18CA	18.0	20.11	22.65	50	30.9	488.7	1500
15KP20A	15KP20CA	20.0	22.34	24.96	20	34.3	440.2	1000
15KP22A	15KP22CA	22.0	24.57	27.46	10	37.1	407.0	500
15KP24A	15KP24CA	24.0	26.81	29.95	5	40.7	371.0	150
15KP26A	15KP26CA	26.0	29.04	32.45	5	44.0	343.2	50
15KP28A	15KP28CA	28.0	31.28	34.95	5	47.5	317.9	25
15KP30A	15KP30CA	30.0	33.51	37.44	5	50.7	297.8	10
15KP33A	15KP33CA	33.0	36.90	41.19	5	54.7	276.1	2
15KP36A	15KP36CA	36.0	40.20	44.93	5	59.8	252.5	2
15KP40A	15KP40CA	40.0	44.70	49.92	5	65.8	229.5	2
15KP43A	15KP43CA	43.0	48.00	53.67	5	69.8	216.3	2
15KP45A	15KP45CA	45.0	50.30	56.16	5	72.8	207.4	2
15KP48A	15KP48CA	48.0	53.60	59.91	5	77.7	194.3	2
15KP51A	15KP51CA	51.0	57.00	63.65	5	82.9	182.1	2
15KP54A	15KP54CA	54.0	60.30	67.39	5	87.7	172.2	2
15KP58A	15KP58CA	58.0	64.80	72.39	5	93.8	161.0	2
15KP60A	15KP60CA	60.0	67.00	74.88	5	97.4	155.0	2
15KP64A	15KP64CA	64.0	71.50	79.87	5	104.2	144.9	2
15KP70A	15KP70CA	70.0	78.20	87.36	5	113.6	132.9	2
15KP75A	15KP75CA	75.0	83.80	93.60	5	122.0	123.8	2
15KP78A	15KP78CA	78.0	87.10	97.35	5	126.1	119.7	2
15KP85A	15KP85CA	85.0	94.90	106.08	5	137.6	109.7	2
15KP90A	15KP90CA	90.0	100.50	112.32	5	145.6	103.7	2
15KP100A	15KP100CA	100.0	111.70	124.80	5	161.3	93.6	2

Electrical Characteristics ($T_A=25^{\circ}\text{C}$)

Part Number		Reverse Stand-Off Voltage	Breakdown Voltage @ I_T		Test Current	Maximum Clamping Voltage @ I_{PP}	Peak Pulse Current	Reverse Leakage @ V_R
Uni.	Bi.	$V_R(V)$	$V_{B \text{ Min.}}(V)$	$V_{B \text{ Max.}}(V)$	$I_T(mA)$	$V_C(V)$	$I_{PP}(A)$	$I_R(\mu A)$
15KP110A	15KP110CA	110.0	122.90	137.28	5	178.6	84.5	2
15KP120A	15KP120CA	120.0	134.00	149.76	5	192.3	78.5	2
15KP130A	15KP130CA	130.0	145.20	162.25	5	208.3	72.5	2
15KP150A	15KP150CA	150.0	167.60	187.21	5	241.9	62.4	2
15KP160A	15KP160CA	160.0	178.70	199.69	5	258.6	58.4	2
15KP170A	15KP170CA	170.0	189.90	212.17	5	272.7	55.4	2
15KP180A	15KP180CA	180.0	201.10	224.65	5	288.5	52.3	2
15KP200A	15KP200CA	200.0	223.40	249.61	5	319.1	47.3	2
15KP220A	15KP220CA	220.0	245.70	274.57	5	352.5	42.8	2
15KP240A	15KP240CA	240.0	268.10	299.53	5	384.6	39.3	2
15KP260A	15KP260CA	260.0	290.40	324.49	5	416.7	36.2	2
15KP280A	15KP280CA	280.0	312.80	349.45	5	454.5	33.2	2

Ratings and Characteristic Curves ($T_A=25^\circ\text{C}$)

Figure 1. Peak Pulse Power Rating Curve

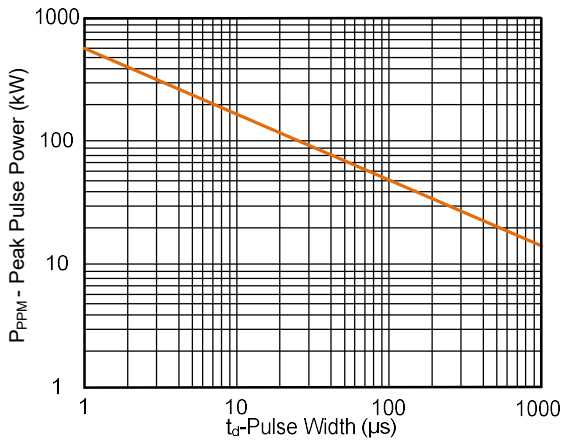

Figure 2. Pulse Derating Curve

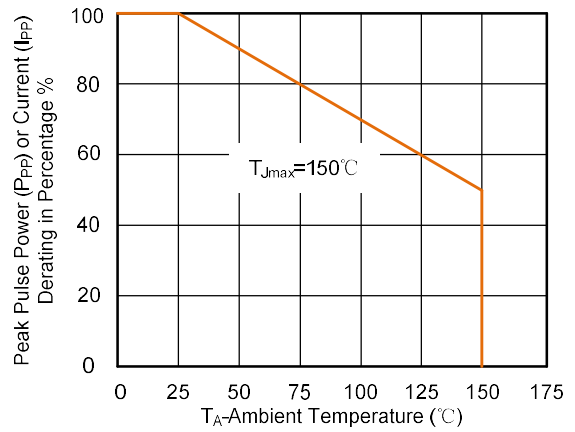

Figure 3. Pulse Waveform

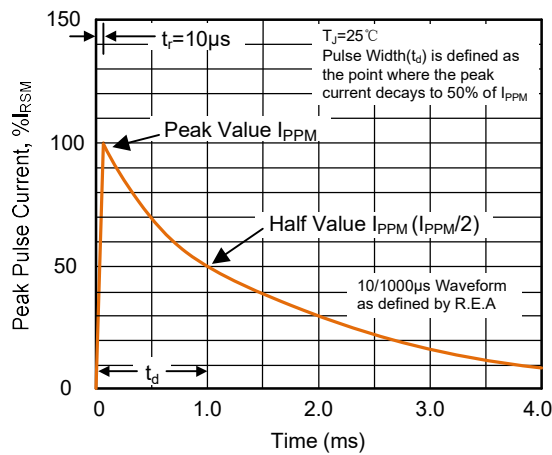

Figure 4. Typical Junction Capacitance

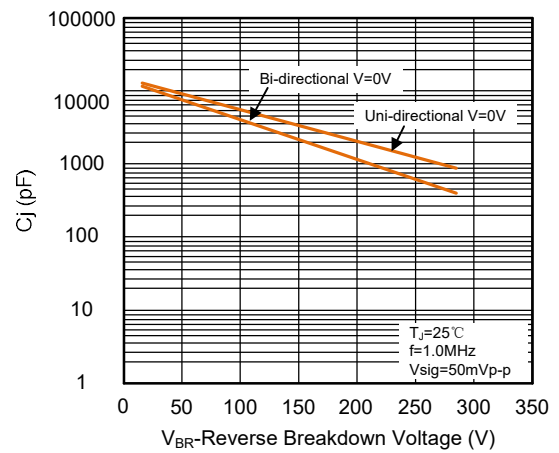

Figure 5. Steady State Power Dissipation Derating Curve

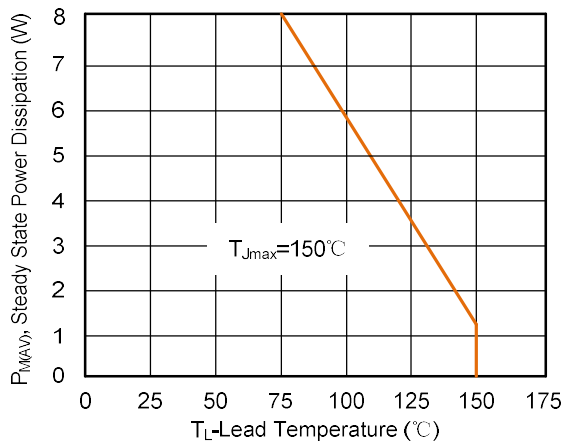
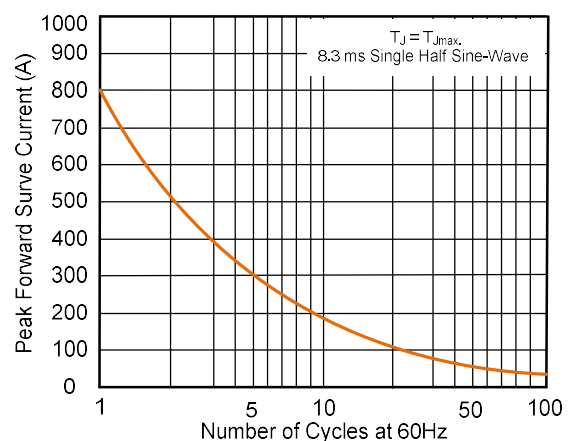
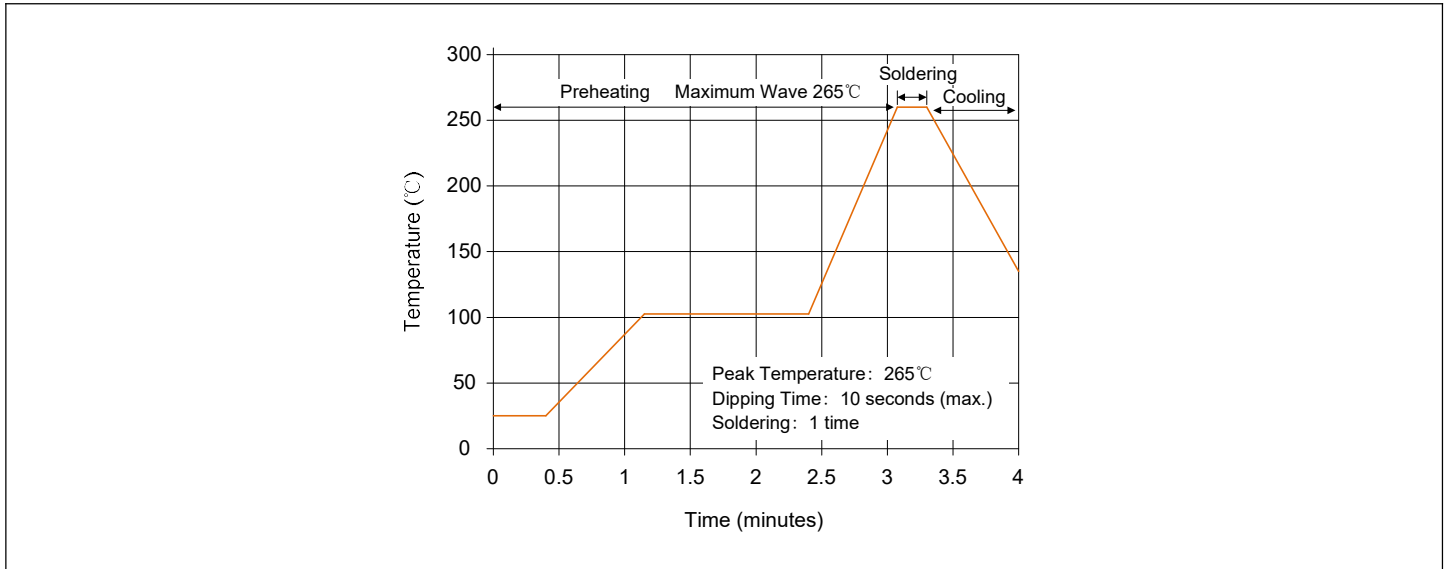

Figure 6. Maximum Non-Repetitive Forward Surge Current Uni-Directional Only



Wave Soldering



Part Number Code and Marking Code

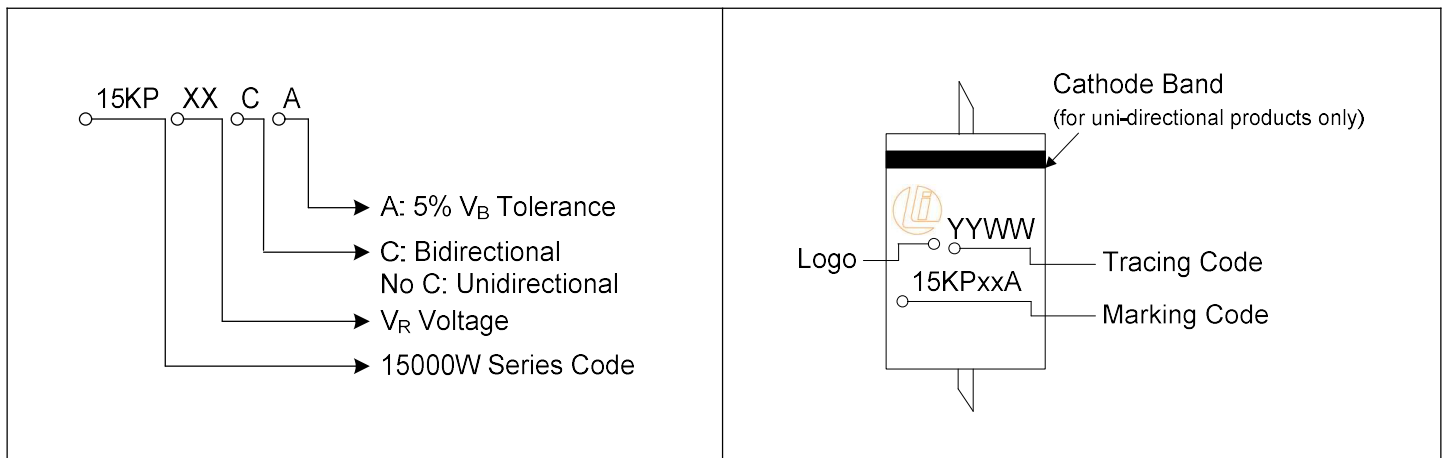

Dimensions (P600)

The diagram shows the dimensions of the TVS diode. A is the length of the leads, B is the width of the body, C is the height of the body, and d is the thickness of the leads.

Symbol	Millimeters		Inches	
	Min.	Max.	Min.	Max.
A	25.40	-	1.000	-
B	8.60	9.10	0.340	0.360
C	8.60	9.10	0.340	0.360
d	1.19	1.35	0.047	0.053

Packaging Specification

Tape

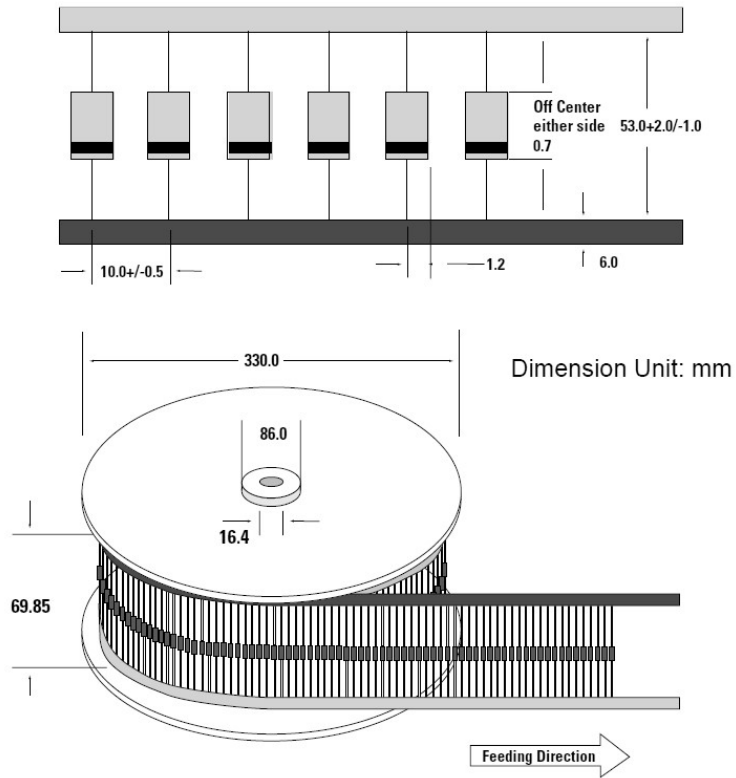

Quantity: 800pcs/reel

Box

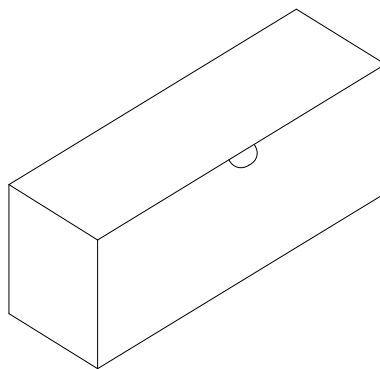

Quantity: 300pcs/box