

## Description

The SMBJ series is designed specifically to protect sensitive electronic equipment from voltage transients induced by lightning and other transient voltage events. For surface mounted applications in order to optimize board space.

## Features

- Halogen free and RoHS compliant
- Low profile package
- Built-in strain relief design
- Low inductance
- Excellent clamping capability
- 600W peak pulse power capability at 10/1000 $\mu$ s waveform, repetition rate (duty cycle): 0.01%
- Fast response time
- Typical  $I_R$  less than 1 $\mu$ A above 10V devices
- Peak 260 $^{\circ}$ C high temperature Reflow Soldering withstanding
- Meet MSL level1, per J-STD-020
- IEC-61000-4-2 ESD 30kV(Air), 30kV (Contact)
- Unit Weight: 0.10g

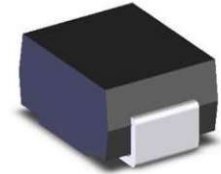

## Applications

TVS components are ideal for the protection of I/O Interfaces, VCC bus and other vulnerable circuits used in telecom, computer, Industrial and consumer electronic applications.

## Maximum Ratings and Characteristics ( $T_A=25^{\circ}\text{C}$ )

Rating	Symbol	Value
Peak pulse power dissipation at 10/1000 $\mu$ s waveform (Note1, Note2, Fig.1)	$P_{PPM}$	600W
Peak pulse current of at 10/1000 $\mu$ s waveform (Note 1, Fig.3)	$I_{PPM}$	See Table(A)
Steady state power dissipation at $T_A=50^{\circ}\text{C}$ (Fig.5)	$P_{M(AV)}$	5.0W
Maximum Instantaneous Forward Voltage at 50A for Unidirectional Only	$V_F$	3.5V/5.0V
Peak forward surge current, 8.3ms single half sine-wave superimposed on rated load, (JEDEC Method) (Note3, Fig.6)	$I_{FSM}$	100A
Operating junction and Storage Temperature Ranges	$T_J, T_{STG}$	-55 $^{\circ}\text{C}$ to +150 $^{\circ}\text{C}$
Typical thermal resistance junction to lead	$R_{\theta JL}$	20 $^{\circ}\text{C}/\text{W}$
Typical thermal resistance junction to ambient	$R_{\theta JA}$	100 $^{\circ}\text{C}/\text{W}$

Notes:1. Non-repetitive current pulse, per Fig.3 and derating above  $T_A=25^{\circ}\text{C}$  per Fig.2.

2. Each terminal is surface Mounted on the 5.0mm $\times$ 5.0mm (0.03mm thick) copper pads.

3. 8.3ms single half sine-wave or equivalent square wave, duty cycle=4 pulses per minutes maximum.

4.  $V_F<3.5\text{V}$  for single die parts and  $V_F<5.0\text{V}$  for stacked-die parts.

**Electrical Characteristics (T<sub>A</sub>=25°C)**

Part Number		Device Marking Code		Reverse Stand-Off Voltage	Breakdown Voltage @I <sub>T</sub>		Test Current	Maximum Clamping Voltage @I <sub>PP</sub>	Peak Pulse Current	Reverse Leakage @V <sub>R</sub>
Uni.	Bi.	Uni.	Bi.	V <sub>R</sub> (V)	V <sub>B Min.</sub> (V)	V <sub>B Max.</sub> (V)	I <sub>T</sub> (mA)	V <sub>C</sub> (V)	I <sub>PP</sub> (A)	I <sub>R</sub> (μA)
SMBJ5.0A	SMBJ5.0CA	KE	AE	5.0	6.40	7.00	10	9.2	65.3	800
SMBJ6.0A	SMBJ6.0CA	KG	AG	6.0	6.67	7.37	10	10.3	58.3	800
SMBJ6.5A	SMBJ6.5CA	KK	AK	6.5	7.22	7.98	10	11.2	53.6	500
SMBJ7.0A	SMBJ7.0CA	KM	AM	7.0	7.78	8.60	10	12.0	50.0	200
SMBJ7.5A	SMBJ7.5CA	KP	AP	7.5	8.33	9.21	1	12.9	46.6	100
SMBJ8.0A	SMBJ8.0CA	KR	AR	8.0	8.89	9.83	1	13.6	44.2	50
SMBJ8.5A	SMBJ8.5CA	KT	AT	8.5	9.44	10.40	1	14.4	41.7	20
SMBJ9.0A	SMBJ9.0CA	KV	AV	9.0	10.00	11.10	1	15.4	39.0	10
SMBJ10A	SMBJ10CA	KX	AX	10.0	11.10	12.30	1	17.0	35.3	5
SMBJ11A	SMBJ11CA	KZ	AZ	11.0	12.20	13.50	1	18.2	33.0	1
SMBJ12A	SMBJ12CA	LE	BE	12.0	13.30	14.70	1	19.9	30.2	1
SMBJ13A	SMBJ13CA	LG	BG	13.0	14.40	15.90	1	21.5	28.0	1
SMBJ14A	SMBJ14CA	LK	BK	14.0	15.60	17.20	1	23.2	25.9	1
SMBJ15A	SMBJ15CA	LM	BM	15.0	16.70	18.50	1	24.4	24.6	1
SMBJ16A	SMBJ16CA	LP	BP	16.0	17.80	19.70	1	26.0	23.1	1
SMBJ17A	SMBJ17CA	LR	BR	17.0	18.90	20.90	1	27.6	21.8	1
SMBJ18A	SMBJ18CA	LT	BT	18.0	20.00	22.10	1	29.2	20.6	1
SMBJ20A	SMBJ20CA	LV	BV	20.0	22.20	24.50	1	32.4	18.6	1
SMBJ22A	SMBJ22CA	LX	BX	22.0	24.40	26.90	1	35.5	16.9	1
SMBJ24A	SMBJ24CA	LZ	BZ	24.0	26.70	29.50	1	38.9	15.5	1
SMBJ26A	SMBJ26CA	ME	CE	26.0	28.90	31.90	1	42.1	14.3	1
SMBJ28A	SMBJ28CA	MG	CG	28.0	31.10	34.40	1	45.4	13.3	1
SMBJ30A	SMBJ30CA	MK	CK	30.0	33.30	36.80	1	48.4	12.4	1
SMBJ33A	SMBJ33CA	MM	CM	33.0	36.70	40.60	1	53.3	11.3	1
SMBJ36A	SMBJ36CA	MP	CP	36.0	40.00	44.20	1	58.1	10.4	1
SMBJ40A	SMBJ40CA	MR	CR	40.0	44.40	49.10	1	64.5	9.3	1
SMBJ43A	SMBJ43CA	MT	CT	43.0	47.80	52.80	1	69.4	8.7	1
SMBJ45A	SMBJ45CA	MV	CV	45.0	50.00	55.30	1	72.7	8.3	1
SMBJ48A	SMBJ48CA	MX	CX	48.0	53.30	58.90	1	77.4	7.8	1
SMBJ51A	SMBJ51CA	MZ	CZ	51.0	56.70	62.70	1	82.4	7.3	1
SMBJ54A	SMBJ54CA	NE	DE	54.0	60.00	66.30	1	87.1	6.9	1

**Electrical Characteristics (T<sub>A</sub>=25°C)**

Part Number		Device Marking Code		Reverse Stand-Off Voltage	Breakdown Voltage @I <sub>T</sub>		Test Current	Maximum Clamping Voltage @I <sub>PP</sub>	Peak Pulse Current	Reverse Leakage @V <sub>R</sub>
Uni.	Bi.	Uni.	Bi.	V <sub>R</sub> (V)	V <sub>B Min.</sub> (V)	V <sub>B Max.</sub> (V)	I <sub>T</sub> (mA)	V <sub>C</sub> (V)	I <sub>PP</sub> (A)	I <sub>R</sub> (μA)
SMBJ58A	SMBJ58CA	NG	DG	58.0	64.40	71.20	1	93.6	6.5	1
SMBJ60A	SMBJ60CA	NK	DK	60.0	66.70	73.70	1	96.8	6.2	1
SMBJ64A	SMBJ64CA	NM	DM	64.0	71.10	78.60	1	103.0	5.9	1
SMBJ70A	SMBJ70CA	NP	DP	70.0	77.80	86.00	1	113.0	5.3	1
SMBJ75A	SMBJ75CA	NR	DR	75.0	83.30	92.10	1	121.0	5.0	1
SMBJ78A	SMBJ78CA	NT	DT	78.0	86.70	95.80	1	126.0	4.8	1
SMBJ85A	SMBJ85CA	NV	DV	85.0	94.40	104.0	1	137.0	4.4	1
SMBJ90A	SMBJ90CA	NX	DX	90.0	100.0	111.0	1	146.0	4.1	1
SMBJ100A	SMBJ100CA	NZ	DZ	100.0	111.00	123.00	1	162.0	3.7	1
SMBJ110A	SMBJ110CA	PE	EE	110.0	122.0	135.0	1	177.0	3.4	1
SMBJ120A	SMBJ120CA	PG	EG	120.0	133.0	147.0	1	193.0	3.1	1
SMBJ130A	SMBJ130CA	PK	EK	130.0	144.0	159.0	1	209.0	2.9	1
SMBJ150A	SMBJ150CA	PM	EM	150.0	167.0	185.0	1	243.0	2.5	1
SMBJ160A	SMBJ160CA	PP	EP	160.0	178.0	197.0	1	259.0	2.3	1
SMBJ170A	SMBJ170CA	PR	ER	170.0	189.0	209.0	1	275.0	2.2	1
SMBJ180A	SMBJ180CA	PT	ET	180.0	201.0	222.0	1	292.0	2.1	1
SMBJ190A	SMBJ190CA	PA	EC	190.0	211.0	233.0	1	308.0	2.0	1
SMBJ200A	SMBJ200CA	PV	EV	200.0	224.0	247.0	1	324.0	1.9	1
SMBJ210A	SMBJ210CA	PB	ED	210.0	237.0	263.0	1	340.0	1.8	1
SMBJ220A	SMBJ220CA	PX	EX	220.0	246.0	272.0	1	356.0	1.7	1
SMBJ250A	SMBJ250CA	PZ	EZ	250.0	279.0	309.0	1	405.0	1.5	1
SMBJ300A	SMBJ300CA	QE	FE	300.0	335.0	371.0	1	486.0	1.3	1
SMBJ350A	SMBJ350CA	QG	FG	350.0	391.0	432.0	1	567.0	1.1	1
SMBJ400A	SMBJ400CA	QK	FK	400.0	447.0	494.0	1	648.0	0.9	1
SMBJ440A	SMBJ440CA	QM	FM	440.0	492.0	543.0	1	713.0	0.9	1
SMBJ480A	SMBJ480CA	QP	FP	480.0	536.5	592.9	1	780.0	0.8	1
SMBJ500A	SMBJ500CA	QR	FR	500.0	558.0	618.0	1	810.0	0.8	1
SMBJ510A	SMBJ510CA	QT	FT	510.0	575.2	628.4	1	828.0	0.73	1
SMBJ550A	SMBJ550CA	QU	FU	550.0	614.0	680.0	1	891.0	0.68	1
SMBJ600A	SMBJ600CA	QV	FV	600.0	670.0	741.0	1	971.0	0.62	1

Ratings and Characteristic Curves ( $T_A=25^\circ\text{C}$ )

Figure 1. Peak Pulse Power Rating Curve

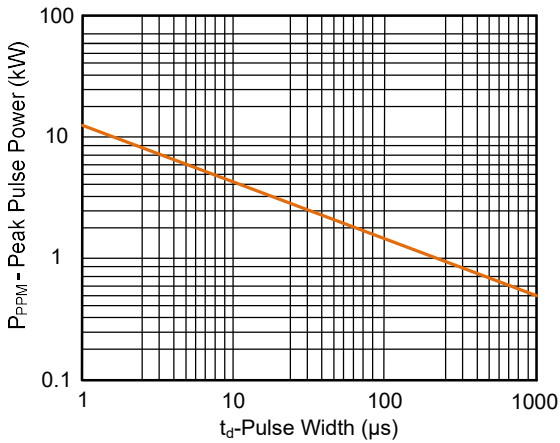

Figure 2. Pulse Derating Curve

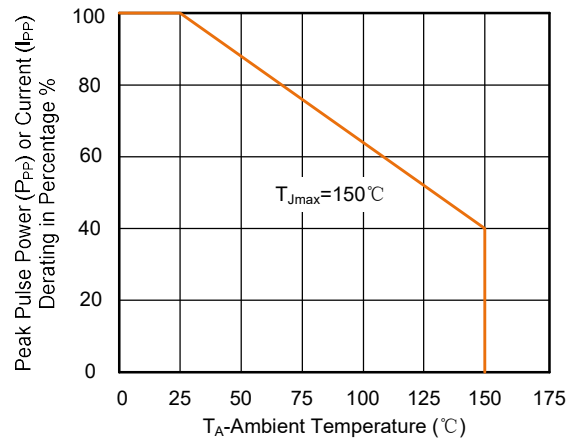

Figure 3. Pulse Waveform

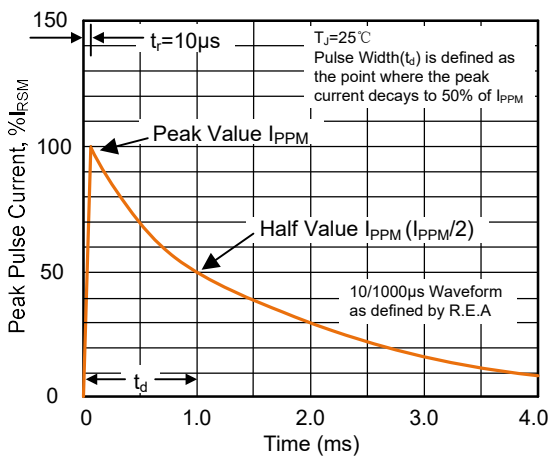

Figure 4. Typical Junction Capacitance

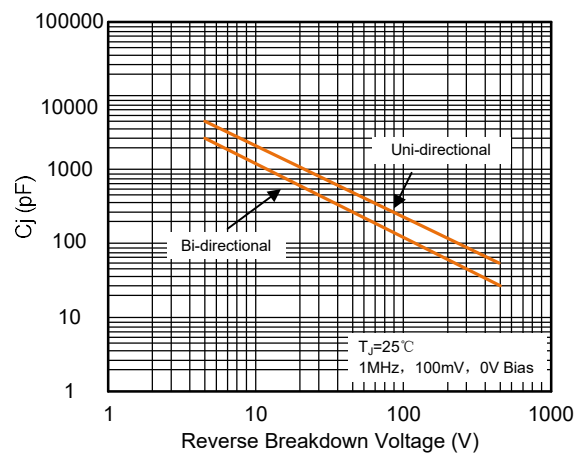

Figure 5. Steady State Power Dissipation Derating Curve

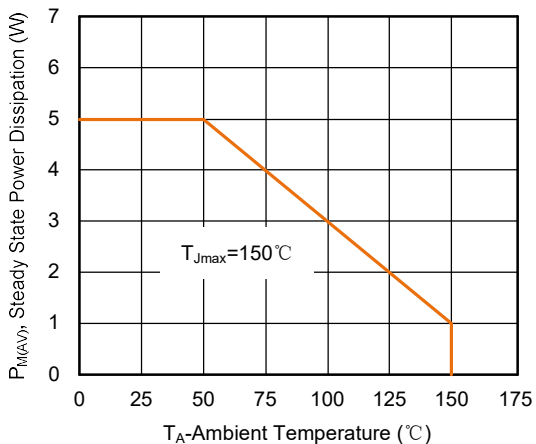
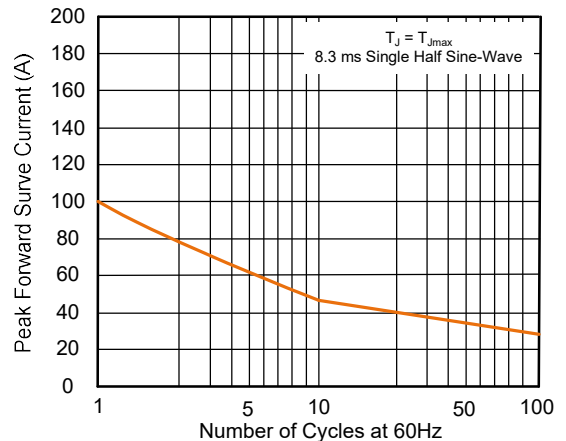
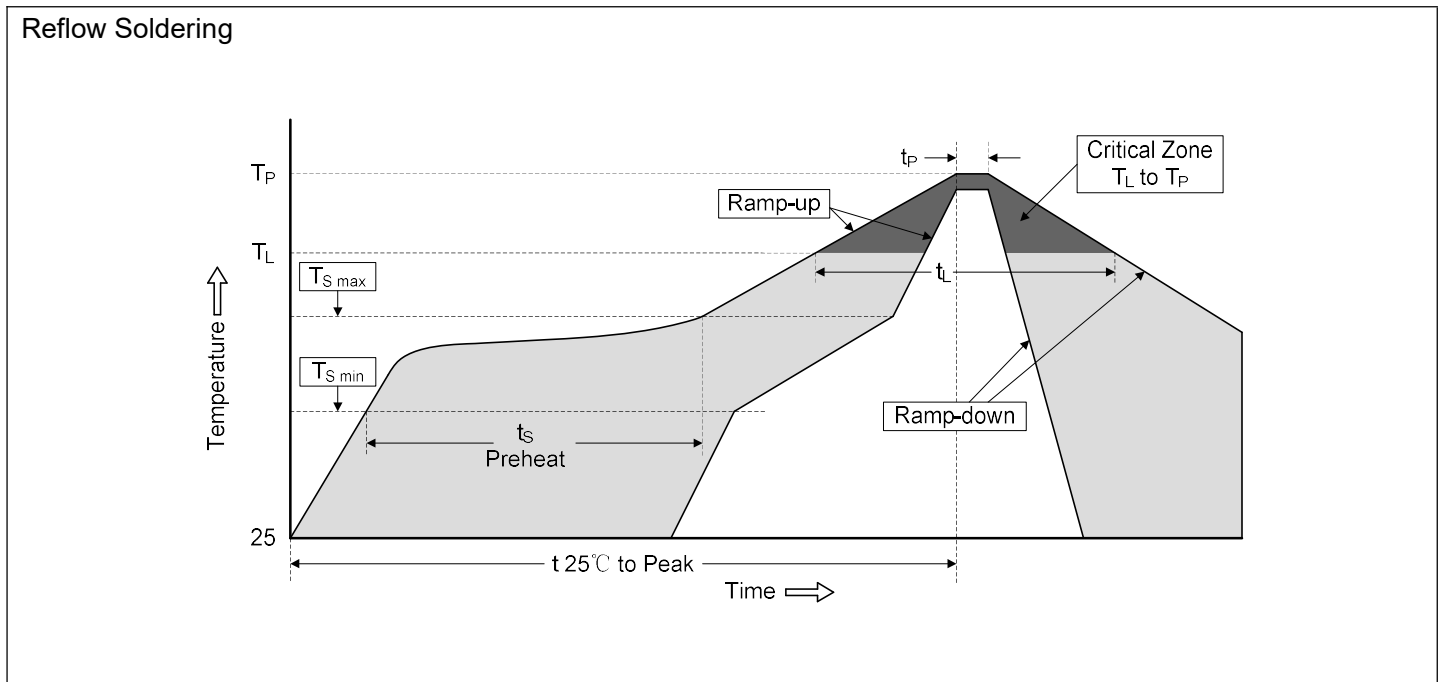

Figure 6. Maximum Non-Repetitive Forward Surge Current Uni-Directional Only



## Soldering Parameters



Profile Feature	Pb-Free Assembly
Average ramp-up rate ( $T_L$ to $T_P$ )	3°C/second max.
Preheat -Temperature Min ( $T_{S\ min}$ ) -Temperature Max ( $T_{S\ max}$ ) -Time (min to max) ( $t_s$ )	150°C 200°C 60-180 seconds
$T_{S\ max}$ to $T_L$ -Ramp-up Rate	3°C/second max.
Time maintained above: -Temperature ( $T_L$ ) -Time ( $t_L$ )	217°C 60-150 seconds
Peak Temperature ( $T_P$ )	260°C
Time within 5°C of actual Peak Temperature ( $t_p$ )	20-40 seconds
Ramp-down Rate	6°C/second max.
Time 25°C to Peak Temperature	8 minutes max.

**Part Number Code and Marking Code**

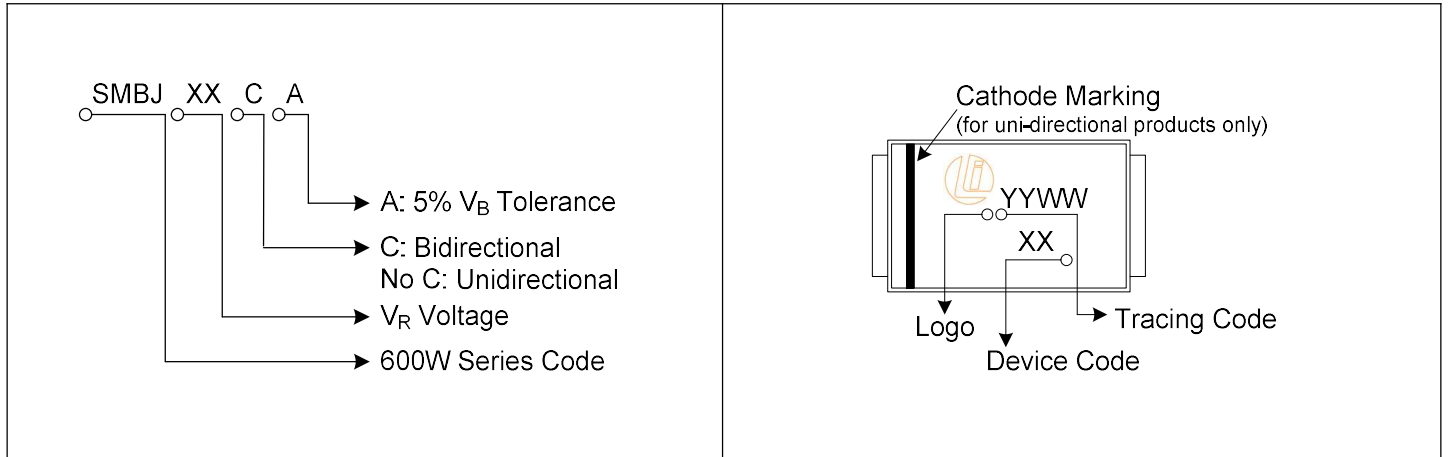

**Dimensions (SMB/DO-214AA)**

The diagram shows the dimensions of the SMB/DO-214AA package. The dimensions are defined as follows:

- A**: Height of the package body
- B**: Width of the package body
- C**: Total height including leads
- D**: Lead height
- E**: Lead width
- F**: Lead thickness
- G**: Total length including leads
- H**: Lead thickness at the top
- I**: Lead thickness at the bottom
- J**: Lead width at the bottom
- K**: Distance between leads

Symbol	Millimeters		Inches	
	Min.	Max.	Min.	Max.
A	1.930	2.200	0.076	0.086
B	4.060	4.750	0.160	0.187
C	3.300	3.940	0.130	0.155
D	2.160	2.650	0.085	0.104
E	0.760	1.520	0.030	0.060
F	-	0.203	-	0.008
G	5.210	5.590	0.205	0.220
H	0.152	0.305	0.006	0.012
I	2.260	-	0.089	-
J	2.160	-	0.085	-
K	-	2.740	-	0.107

## Packaging Specification

### Tape

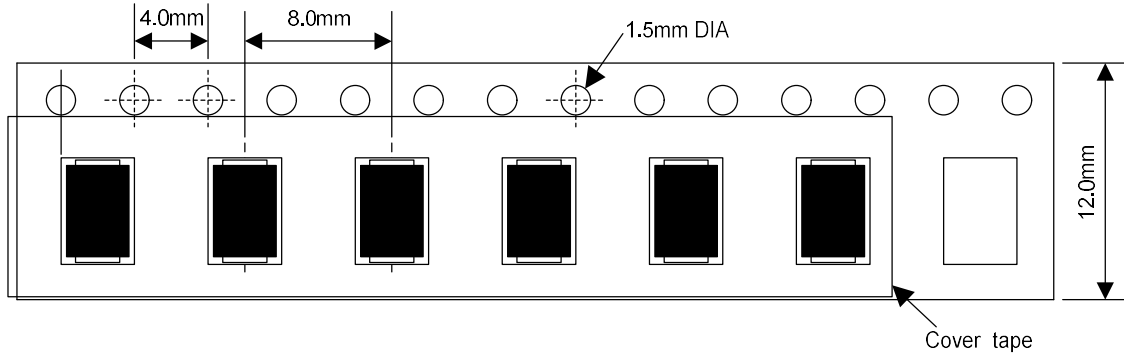

### For Uni-Devices

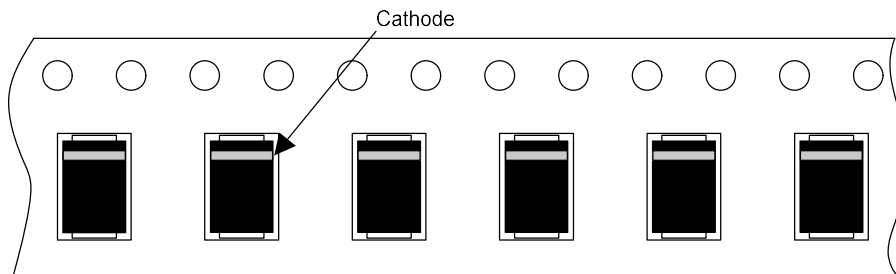

### 13 Inches Reel

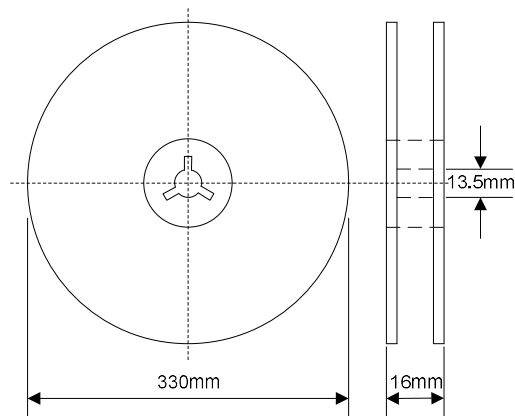

Quantity: 3000pcs/reel