

Description

The P6SMAJ series is designed specifically to protect sensitive electronic equipment from voltage transients induced by lightning and other transient voltage events. For surface mounted applications in order to optimize board space.

Features

- Halogen free and RoHS compliant
- Low profile package
- Built-in strain relief design
- Low inductance
- Excellent clamping capability
- 600W peak pulse power capability at 10/1000 μ s waveform, repetition rate (duty cycle): 0.01%
- Fast response time
- Typical I_R less than 1 μ A above 10V devices
- Peak 260 $^{\circ}$ C high temperature Reflow Soldering withstanding
- Meet MSL level1, per J-STD-020
- IEC-61000-4-2 ESD 30kV(Air), 30kV (Contact)
- Unit Weight: 0.07g

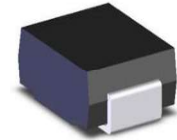

Applications

TVS components are ideal for the protection of I/O Interfaces, VCC bus and other vulnerable circuits used in telecom, computer, Industrial and consumer electronic applications.

Maximum Ratings and Characteristics ($T_A=25^{\circ}\text{C}$)

Rating	Symbol	Value
Peak pulse power dissipation at 10/1000 μ s waveform (Note1, Note2, Fig.1)	P_{PPM}	600W
Peak pulse current of at 10/1000 μ s waveform (Note 1, Fig.3)	I_{PPM}	See Table(A)
Steady state power dissipation at $T_A=50^{\circ}\text{C}$ (Fig.5)	$P_{M(AV)}$	5.0W
Maximum Instantaneous Forward Voltage at 25A for Unidirectional Only	V_F	3.5V
Peak forward surge current, 8.3ms single half sine-wave superimposed on rated load, (JEDEC Method) (Note3, Fig.6)	I_{FSM}	60A
Operating junction and Storage Temperature Ranges	T_J, T_{STG}	-55 $^{\circ}\text{C}$ to +150 $^{\circ}\text{C}$
Typical thermal resistance junction to lead	$R_{\theta JL}$	30 $^{\circ}\text{C/W}$
Typical thermal resistance junction to ambient	$R_{\theta JA}$	120 $^{\circ}\text{C/W}$

Notes:1. Non-repetitive current pulse, per Fig.3 and derating above $T_A=25^{\circ}\text{C}$ per Fig.2.

2. Each terminal is surface Mounted on the 5.0mm \times 5.0mm (0.03mm thick) copper pads.

3. 8.3ms single half sine-wave or equivalent square wave, duty cycle=4 pulses per minutes maximum.

Electrical Characteristics (T_A=25°C)

Part Number		Device Marking Code		Reverse Stand-Off Voltage	Breakdown Voltage @I _T		Test Current	Maximum Clamping Voltage @I _{PP}	Peak Pulse Current	Reverse Leakage @V _R
Uni.	Bi.	Uni.	Bi.	V _R (V)	V _{B Min.} (V)	V _{B Max.} (V)	I _T (mA)	V _C (V)	I _{PP} (A)	I _R (μA)
P6SMAJ5.0A	P6SMAJ5.0CA	KE	AE	5.0	6.40	7.00	10	9.2	65.3	800
P6SMAJ6.0A	P6SMAJ6.0CA	KG	AG	6.0	6.67	7.37	10	10.3	58.3	800
P6SMAJ6.5A	P6SMAJ6.5CA	KK	AK	6.5	7.22	7.98	10	11.2	53.6	500
P6SMAJ7.0A	P6SMAJ7.0CA	KM	AM	7.0	7.78	8.60	10	12.0	50.0	200
P6SMAJ7.5A	P6SMAJ7.5CA	KP	AP	7.5	8.33	9.21	1	12.9	46.6	100
P6SMAJ8.0A	P6SMAJ8.0CA	KR	AR	8.0	8.89	9.83	1	13.6	44.2	50
P6SMAJ8.5A	P6SMAJ8.5CA	KT	AT	8.5	9.44	10.40	1	14.4	41.7	20
P6SMAJ9.0A	P6SMAJ9.0CA	KV	AV	9.0	10.00	11.10	1	15.4	39.0	10
P6SMAJ10A	P6SMAJ10CA	KX	AX	10.0	11.10	12.30	1	17.0	35.3	5
P6SMAJ11A	P6SMAJ11CA	KZ	AZ	11.0	12.20	13.50	1	18.2	33.0	1
P6SMAJ12A	P6SMAJ12CA	LE	BE	12.0	13.30	14.70	1	19.9	30.2	1
P6SMAJ13A	P6SMAJ13CA	LG	BG	13.0	14.40	15.90	1	21.5	28.0	1
P6SMAJ14A	P6SMAJ14CA	LK	BK	14.0	15.60	17.20	1	23.2	25.9	1
P6SMAJ15A	P6SMAJ15CA	LM	BM	15.0	16.70	18.50	1	24.4	24.6	1
P6SMAJ16A	P6SMAJ16CA	LP	BP	16.0	17.80	19.70	1	26.0	23.1	1
P6SMAJ17A	P6SMAJ17CA	LR	BR	17.0	18.90	20.90	1	27.6	21.8	1
P6SMAJ18A	P6SMAJ18CA	LT	BT	18.0	20.00	22.10	1	29.2	20.6	1
P6SMAJ20A	P6SMAJ20CA	LV	BV	20.0	22.20	24.50	1	32.4	18.6	1
P6SMAJ22A	P6SMAJ22CA	LX	BX	22.0	24.40	26.90	1	35.5	16.9	1
P6SMAJ24A	P6SMAJ24CA	LZ	BZ	24.0	26.70	29.50	1	38.9	15.5	1
P6SMAJ26A	P6SMAJ26CA	ME	CE	26.0	28.90	31.90	1	42.1	14.3	1
P6SMAJ28A	P6SMAJ28CA	MG	CG	28.0	31.10	34.40	1	45.4	13.3	1
P6SMAJ30A	P6SMAJ30CA	MK	CK	30.0	33.30	36.80	1	48.4	12.4	1
P6SMAJ33A	P6SMAJ33CA	MM	CM	33.0	36.70	40.60	1	53.3	11.3	1
P6SMAJ36A	P6SMAJ36CA	MP	CP	36.0	40.00	44.20	1	58.1	10.4	1
P6SMAJ40A	P6SMAJ40CA	MR	CR	40.0	44.40	49.10	1	64.5	9.3	1

Electrical Characteristics (T_A=25°C)

Part Number		Device Marking Code		Reverse Stand-Off Voltage	Breakdown Voltage @I _T		Test Current	Maximum Clamping Voltage @I _{PP}	Peak Pulse Current	Reverse Leakage @V _R
Uni.	Bi.	Uni.	Bi.	V _R (V)	V _{B Min.} (V)	V _{B Max.} (V)	I _T (mA)	V _C (V)	I _{PP} (A)	I _R (μA)
P6SMAJ43A	P6SMAJ43CA	MT	CT	43.0	47.80	52.80	1	69.4	8.7	1
P6SMAJ45A	P6SMAJ45CA	MV	CV	45.0	50.00	55.30	1	72.7	8.3	1
P6SMAJ48A	P6SMAJ48CA	MX	CX	48.0	53.30	58.90	1	77.4	7.8	1
P6SMAJ51A	P6SMAJ51CA	MZ	CZ	51.0	56.70	62.70	1	82.4	7.3	1
P6SMAJ54A	P6SMAJ54CA	NE	DE	54.0	60.00	66.30	1	87.1	6.9	1
P6SMAJ58A	P6SMAJ58CA	NG	DG	58.0	64.40	71.20	1	93.6	6.5	1
P6SMAJ60A	P6SMAJ60CA	NK	DK	60.0	66.70	73.70	1	96.8	6.2	1
P6SMAJ64A	P6SMAJ64CA	NM	DM	64.0	71.10	78.60	1	103.0	5.9	1
P6SMAJ70A	P6SMAJ70CA	NP	DP	70.0	77.80	86.00	1	113.0	5.3	1
P6SMAJ75A	P6SMAJ75CA	NR	DR	75.0	83.30	92.10	1	121.0	5.0	1
P6SMAJ78A	P6SMAJ78CA	NT	DT	78.0	86.70	95.80	1	126.0	4.8	1
P6SMAJ85A	P6SMAJ85CA	NV	DV	85.0	94.40	104.0	1	137.0	4.4	1
P6SMAJ90A	P6SMAJ90CA	NX	DX	90.0	100.0	111.0	1	146.0	4.1	1
P6SMAJ100A	P6SMAJ100CA	NZ	DZ	100.0	111.00	123.00	1	162.0	3.7	1
P6SMAJ110A	P6SMAJ110CA	PE	EE	110.0	122.0	135.0	1	177.0	3.4	1
P6SMAJ120A	P6SMAJ120CA	PG	EG	120.0	133.0	147.0	1	193.0	3.1	1
P6SMAJ130A	P6SMAJ130CA	PK	EK	130.0	144.0	159.0	1	209.0	2.9	1
P6SMAJ150A	P6SMAJ150CA	PM	EM	150.0	167.0	185.0	1	243.0	2.5	1
P6SMAJ160A	P6SMAJ160CA	PP	EP	160.0	178.0	197.0	1	259.0	2.3	1
P6SMAJ170A	P6SMAJ170CA	PR	ER	170.0	189.0	209.0	1	275.0	2.2	1
P6SMAJ180A	P6SMAJ180CA	PT	ET	180.0	201.0	222.0	1	292.0	2.1	1
P6SMAJ190A	P6SMAJ190CA	PA	EC	190.0	211.0	233.0	1	308.0	2.0	1
P6SMAJ200A	P6SMAJ200CA	PV	EV	200.0	224.0	247.0	1	324.0	1.9	1
P6SMAJ210A	P6SMAJ210CA	PB	ED	210.0	237.0	263.0	1	340.0	1.8	1
P6SMAJ220A	P6SMAJ220CA	PX	EX	220.0	246.0	272.0	1	356.0	1.7	1
P6SMAJ250A	P6SMAJ250CA	PZ	EZ	250.0	279.0	309.0	1	405.0	1.5	1

Ratings and Characteristic Curves ($T_A=25^\circ\text{C}$)

Figure 1. Peak Pulse Power Rating Curve

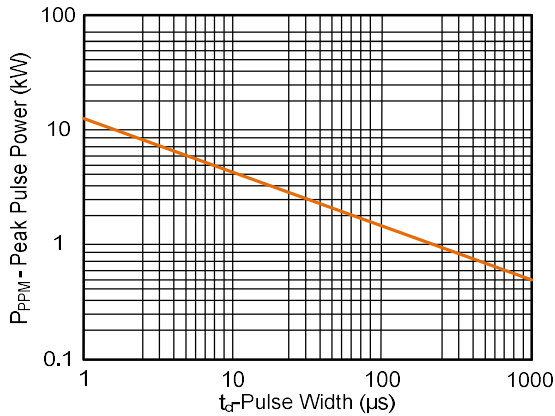

Figure 2. Pulse Derating Curve

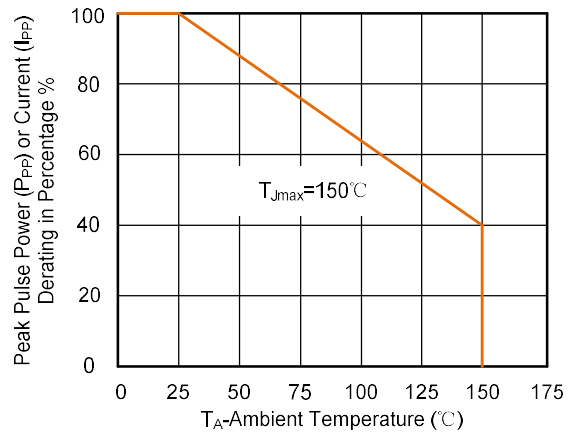

Figure 3. Pulse Waveform

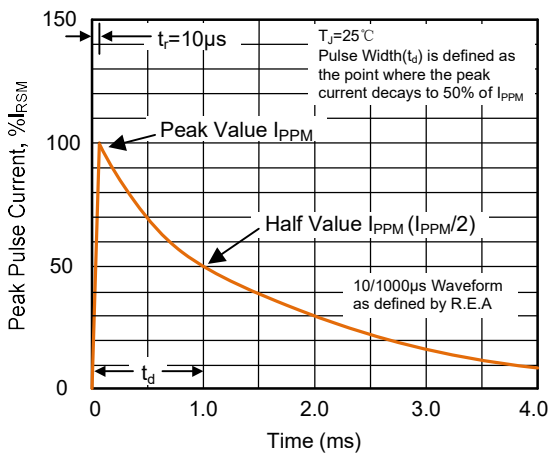

Figure 4. Typical Junction Capacitance

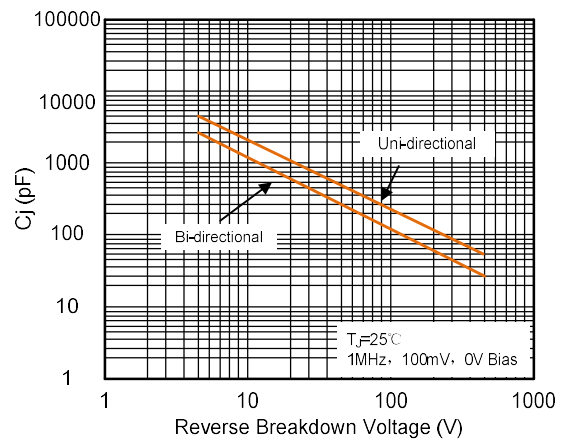

Figure 5. Steady State Power Dissipation Derating Curve

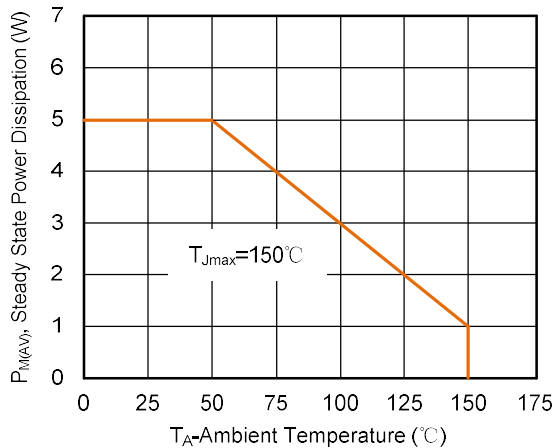
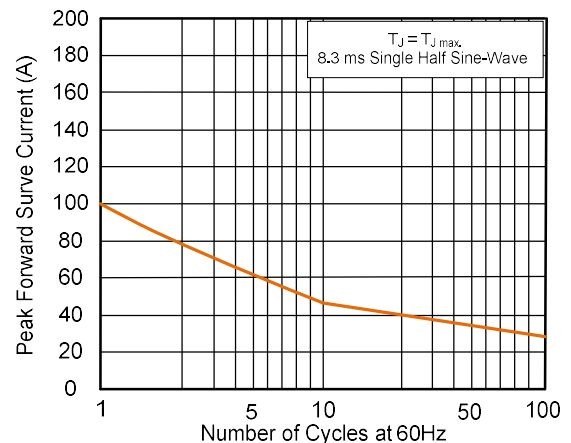
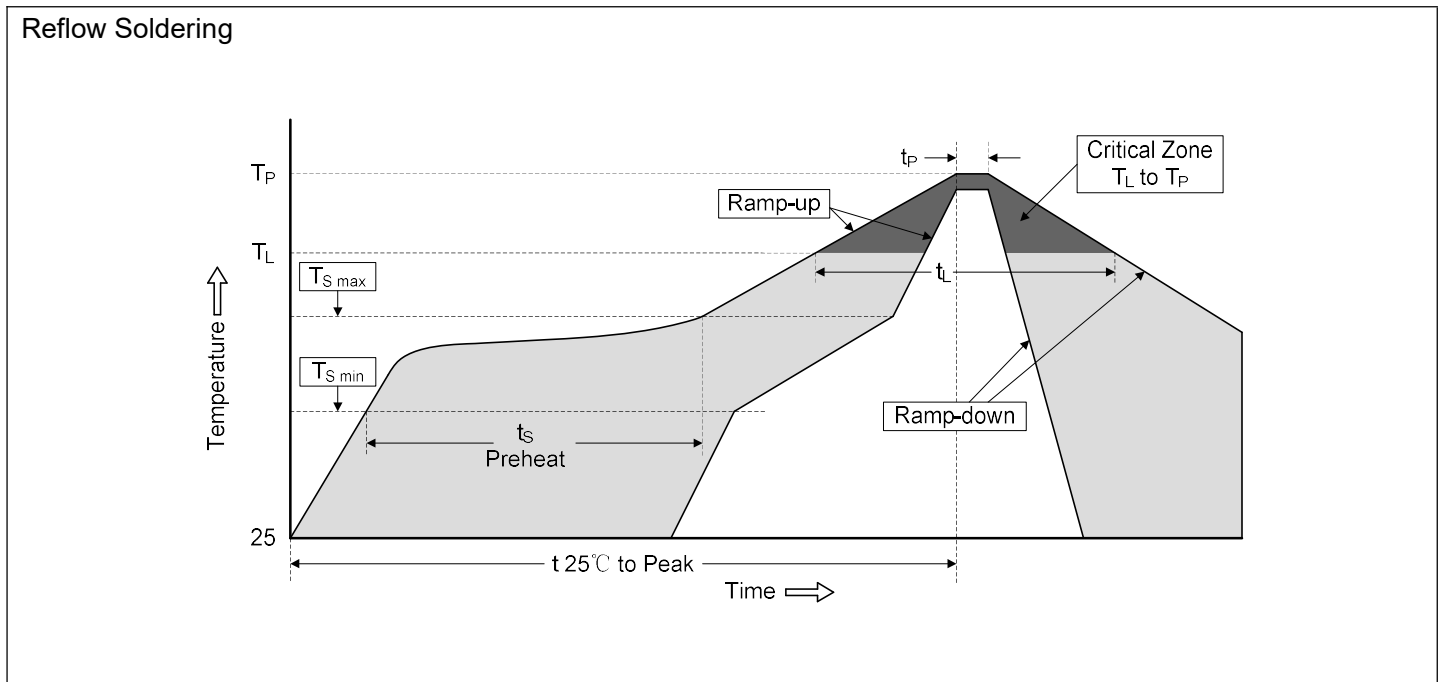

Figure 6. Maximum Non-Repetitive Forward Surge Current Uni-Directional Only



Soldering Parameters



Profile Feature	Pb-Free Assembly
Average ramp-up rate (T_L to T_P)	3°C/second max.
Preheat -Temperature Min ($T_{S\ min}$) -Temperature Max ($T_{S\ max}$) -Time (min to max) (t_s)	150°C 200°C 60-180 seconds
$T_{S\ max}$ to T_L -Ramp-up Rate	3°C/second max.
Time maintained above: -Temperature (T_L) -Time (t_L)	217°C 60-150 seconds
Peak Temperature (T_P)	260°C
Time within 5°C of actual Peak Temperature (t_p)	20-40 seconds
Ramp-down Rate	6°C/second max.
Time 25°C to Peak Temperature	8 minutes max.

Part Number Code and Marking Code

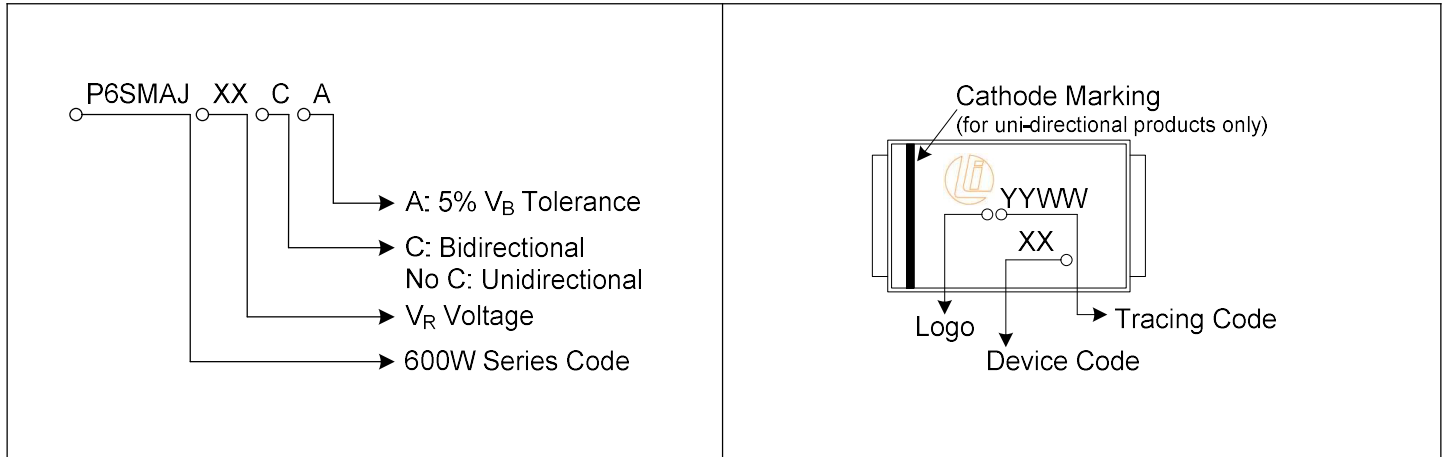

Dimensions (SMA/DO-214AC)

The diagram shows the dimensions of the SMA/DO-214AC package. Dimensions A through K are defined as follows:

- A: Cathode Band width (for uni-directional products only)
- B: Package width
- C: Package height
- D: Lead height
- E: Lead width
- F: Lead thickness
- G: Lead length
- H: Lead diameter
- I: Lead diameter
- J: Lead diameter
- K: Lead length

Symbol	Millimeters		Inches	
	Min.	Max.	Min.	Max.
A	1.250	1.650	0.049	0.065
B	3.990	4.600	0.157	0.181
C	2.400	2.790	0.095	0.110
D	1.900	2.290	0.075	0.090
E	0.780	1.520	0.030	0.060
F	-	0.203	-	0.008
G	4.800	5.280	0.189	0.208
H	0.152	0.305	0.006	0.012
I	1.800	-	0.070	-
J	2.100	-	0.082	-
K	-	2.300	-	0.090

Packaging Specification

Tape

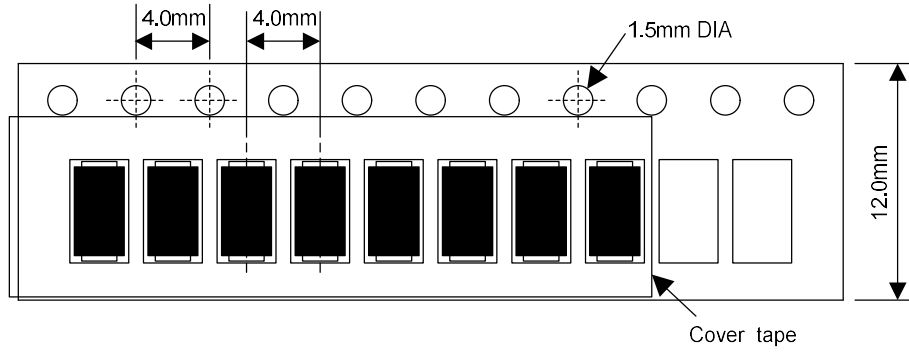

For Uni-Devices

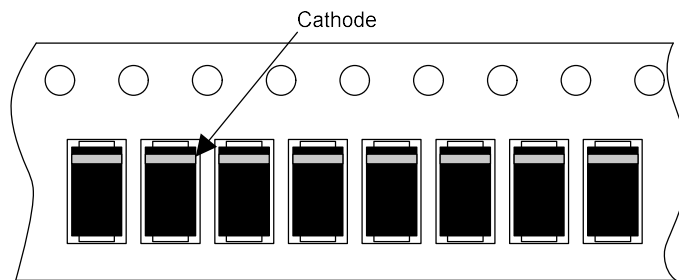

13 Inches Reel

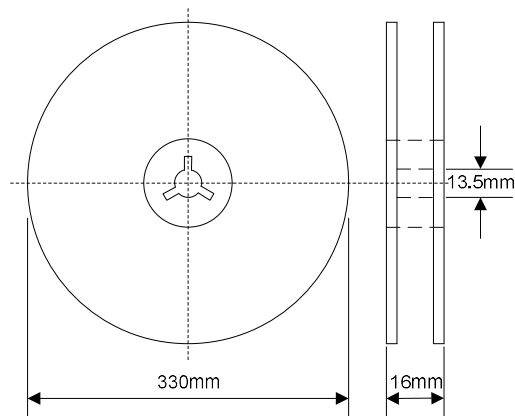

Quantity: 5000pcs/reel